



Since 1931

New Method Steel Stamps, Inc.

31313 Kendall Ave, P.O Box 338 – Fraser, Michigan 48026 – USA
(586) 293-0200 * (800) 582-0199 – Fax (586) 296-1900 .Email: info@newmethod.com

model
604-1





Since 1931

New Method Steel Stamps, Inc.

31313 Kendall Ave, P.O. Box 338 – Fraser, Michigan 48026 – USA
(586) 293-0200 * (800) 582-0199 – Fax (586) 296-1900 .Email: info@newmethod.com

604-1

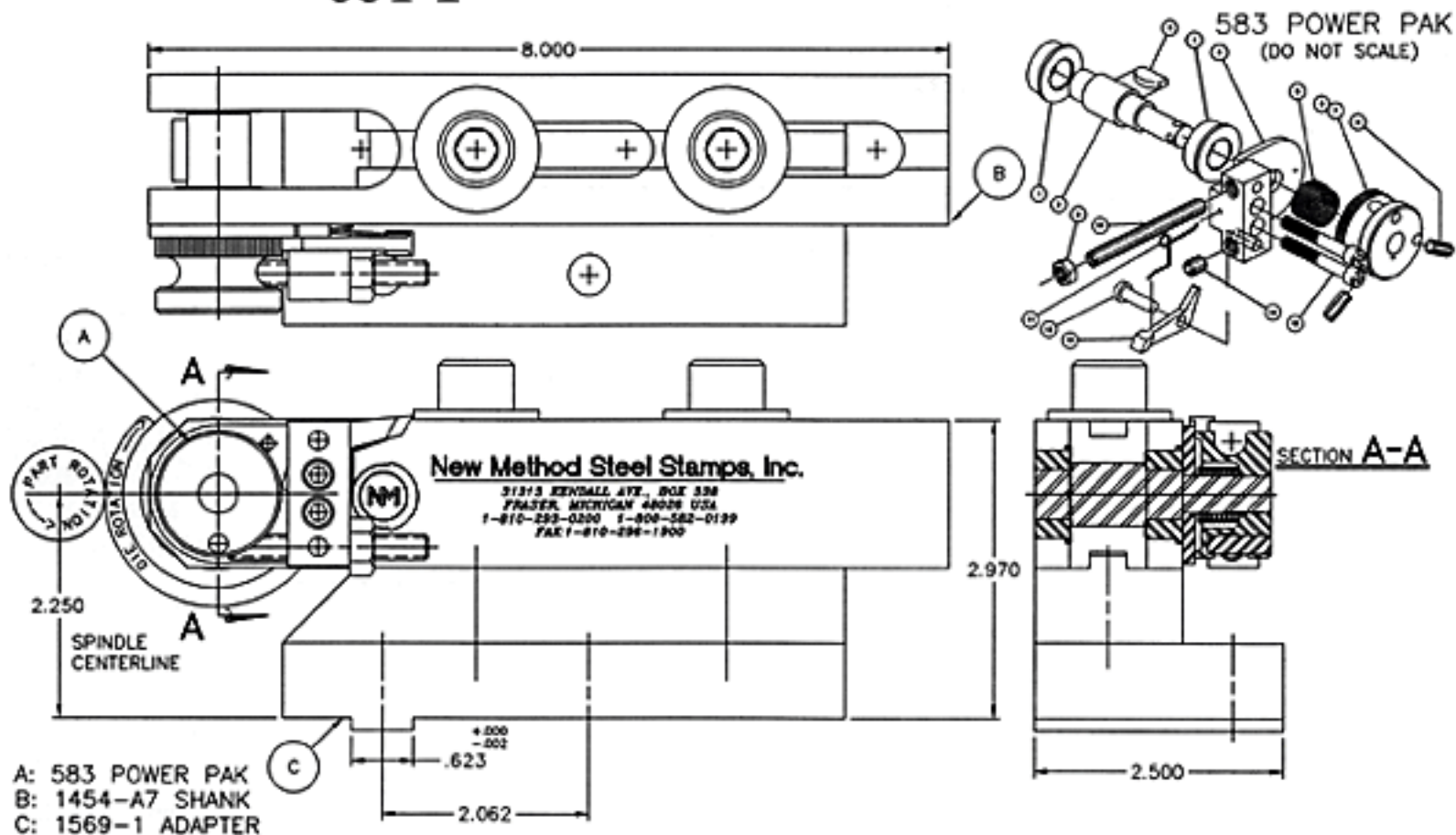



Since 1931

New Method Steel Stamps, Inc.

31313 Kendall Ave, P.O. Box 338 – Fraser, Michigan 48026 – USA
(586) 293-0200 * (800) 582-0199 – Fax (586) 296-1900 .Email: info@newmethod.com

583 POWER PAK

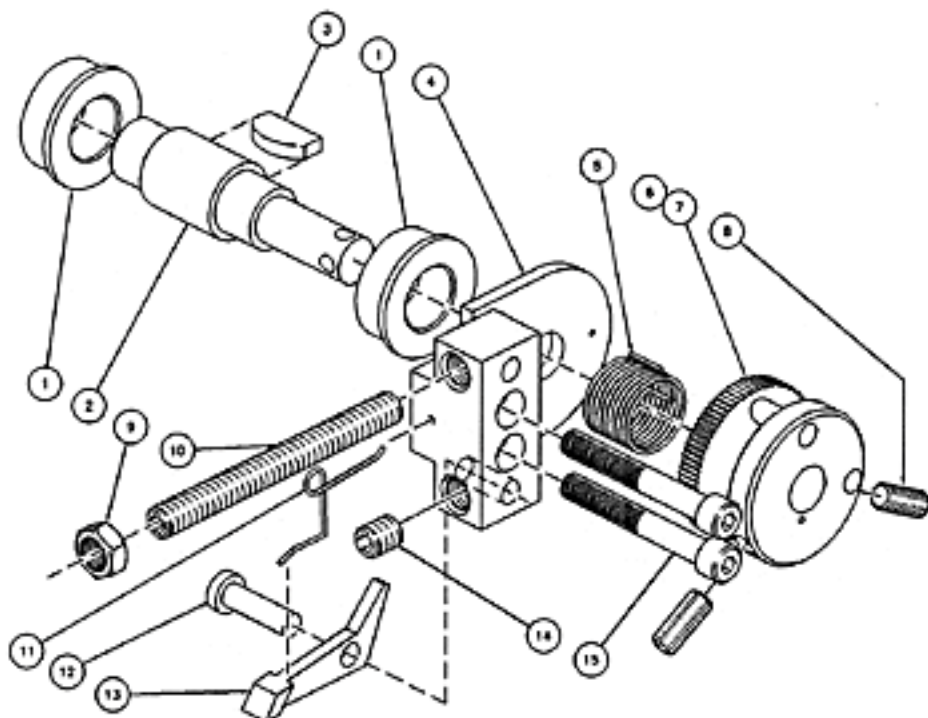

USED ON
ALL 1454
BASED
ATTACHMENTS
951-TH
815

15	1229	1	SOCKET HEAD CAP SCREW
14	1016	1	SET SCREW
13	1100	1	RATCHET PAWL
12	1011	1	AXLE, RATCHET PAWL
11	1456	1	SPRING, RATCHET PAWL
10	1019	1	SET SCREW
9	1018	1	JAM NUT
8	1015	2	SET SCREW
7	1002	1	STOP PIN
6	1001	1	CAP
5	1006	1	SPRING, ROLL RETURN
4	1457	1	ASSY PLATE & BLOCK
3	1012	1	#8 WOODRUFF KEY
2	1459	1	AXLE
1	1460	2	BUSHING
ITEM #	CAT. #	QTY	DESCRIPTION